

EOS

EOS

La libertà di progettare che si combina con la bellezza del risultato.

L'eleganza dinamica dell'arredare con empatia e gusto.

Il talento di rendere semplici le cose più complesse...

Un arredo originale che migliora la performance e rende diverso vivere lo spazio di lavoro.

EOS sa sorprenderti!

The freedom to design that combines with the beauty of the result.

The dynamic elegance of furnishing with empathy and taste.

The talent to make the most complex things simple...

An original piece of furniture that improves performance and makes living in the work space different.

EOS knows how to surprise you!





LO STILE ESALTA IL GUSTO

STYLE ENHANCES TASTE

Il giusto equilibrio tra pieni e vuoti, nasce dall'integrazione delle forme.
Vuoti e pieni s'incontrano in un gioco di linee estremamente gradevole.

*The right balance between solids and voids comes from the integration of shapes.
Empty and full meet in an extremely pleasant play of lines.*



Scrivania con piano diritto in vetro Bianco, gambe in metallo verniciato Bianco, con servente in finitura Bianco
Desk with straight White finish top, White finish U-shaped metal legs, and Elm finish wall unit



Dettaglio del mobile servente
Detail of the corner that enhances the inclination of the internal cut of the leg



Variante del piano melaminico in finitura marmo Michelangelo
Front view of the straight top

Scrivania con piano diritto in finitura Larice, gambe in metallo verniciato Antracite, Modesti pannel in finitura Larice, mobile di servizio in finitura Larice
Desk with straight Walnut finish top and Anthracite painted U-shaped metal legs



Dettaglio dalla gamba aperta
Overhead view of the straight top



Dettaglio della finitura Larice
Detail of Anthracite metal legs with straight top

Scrivania e tavolo con piano diritto in finitura Samui, gambe in metallo verniciato Antracite
Desk with straight Glass top and Anthracite painted U-shaped metal legs





Variante del pino del tavolo riunioni in melaminico finitura marmo Hermitage, gambe in metallo verniciato Antracite

View of desk with straight glass top



Dettaglio dall'alto della scrivania con allungo

Overhead view of the glass top



Scrivanía con piano diríto in finitura Seppia, gambe in metallo verniciato Antracite, mobile servente in finitura Seppia
Operative desk 180x60 cm, with straight Elm finish top and White painted simple metal legs



Variante del piano in melaminico in finitura marmo Hermitage
Overhead view of the glass top



Dettaglio del mobile servente
Overhead view of the glass top



Desk with straight Grey finish top and Anthracite painted simple metal legs



Seravana con piano dritto in finitura Rovere, gambe in metallo verniciato Antracite, mobile servente in finitura Seppia e Rovere
Desk with straight Grey finish top and Anthracite painted simple metal legs



Variante in finitura Tortora con gambe in metallo verniciato Bianco
 Desk with straight Grey finish top and Anthracite painted simple metal legs



Dettaglio del mobile servente
 Overhead view of the glass top



Tavolo riunione con piano in Noce, gambe in metallo verniciato Antracite
Desk with straight Grey finish top and Anthracite painted simple metal legs



Dettaglio della libreria a muro, struttura in metallo verniciato Antracite, piani in finitura Noce
Overhead view of the glass top



Dettaglio dall'alto del tavolo riunione



UNA FORTE PERSONALITÀ...

A STRONG PERSONALITY...

*Le finiture vestono le linee e permettono di comporre con estetica e comfort tutti gli ambienti.
The finishes dress the lines and allow you to compose all environments with aesthetics and comfort.*



Scrivanìa con piano diritto in vetro Antracite, gambe in metallo verniciato Antracite, mobile servente in Olmo
Desk with straight glass top, White painted U-shaped metal legs and Samui finish side unit with drawers



Dettaglio della piano in vetro Antracite
Detail of the U-shaped legs



Dettaglio della struttura della scrivania
Aerial view of the glass-top desk



Tavolo riunione con piano finitura Samui, gambe in metallo verniciato Antracite
Desk with straight top, open Walnut finish side unit and Anthracite painted U-shaped metal legs



Dettaglio della gamba elettrificata del tavolo riunione e della libreria
Detail of the open side unit



Variante del piano in Marmo finitura Hermitage
Overhead view of the straight top

Finiture piani e finiture cassa/

Tops finishing and structure finishing

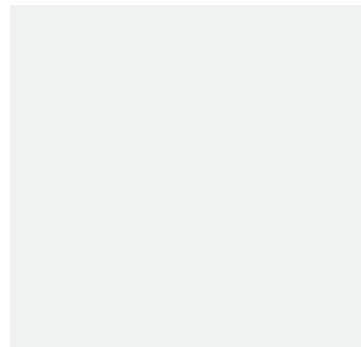

Bianco / finitura piani - finitura cassa
White / top finishing - structure finishing



Grigio / finitura piani - finitura cassa
Grey / top finishing - structure finishing



Seppia / finitura piani - finitura cassa
Sepia / top finishing - structure finishing



Torotorà / finitura piani
Torotorà / top finishing



Samui / finitura piani - finitura cassa
Samui / top finishing - structure finishing



Olmo / finitura piani - finitura cassa
Elm / top finishing - structure finishing

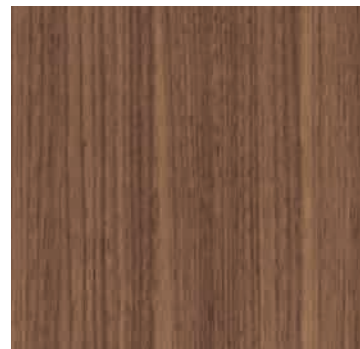

Noce / finitura piani - finitura cassa
Walnut / top finishing - structure finishing



Rovere / finitura piani - finitura cassa
Oak / top finishing - structure finishing



Larice / finitura piani
Larch / top finishing

Finiture Piani Marmo / Marbles Tops finishing



Michelangelo / finitura piani
Michelangelo / top finishing

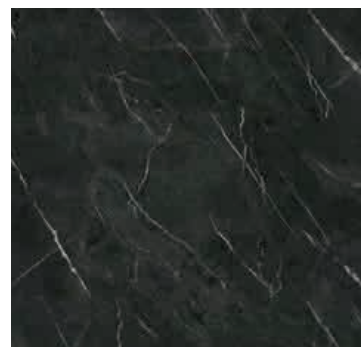

Hermitage / finitura piani
Hermitage / top finishing

Gambe Direzionali

Directional legs



Gamba metallo verniciato Antracite /
Anthracite painted metal leg



Gamba metallo verniciato Bianco /
White painted metal leg

Gambe Tavoli riunione

Conference table legs



Gamba metallo verniciato Antracite /
Anthracite painted metal leg



Gamba metallo verniciato Bianco /
White painted metal leg

Gambe / Legs

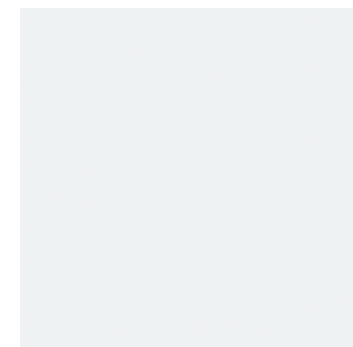

Bianco ral 9010 / White ral 9010



Antracite ral 7022 / Anthracite ral 7022

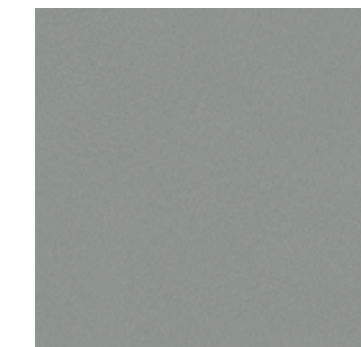

Alluminio ral 9006 / Aluminum ral 9006

ABACO

Un arredo innovativo per il suo approccio di forte componibilità. Estremamente elegante e sofisticato, sentitamente contemporaneo nella scelta di finiture che esaltano le caratteristiche estetiche delle linee progettuali dei singoli elementi. Dalle scrivanie, ai tavoli meeting, agli elementi libreria quelli per archiviare.

An innovative piece of furniture for its highly modular approach. Extremely elegant and sophisticated, resolutely contemporary in the choice of finishes that enhance the aesthetic characteristics of the design lines of the individual elements. From desks, to meeting tables, to bookcase elements to those for filing, eas.

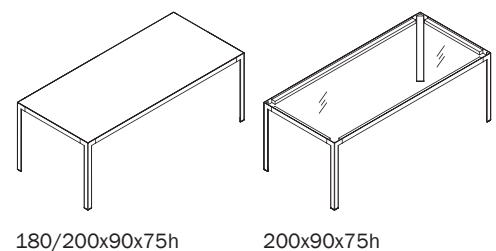

180/200x90x75h

200x90x75h

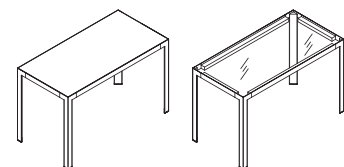

100x60x75h

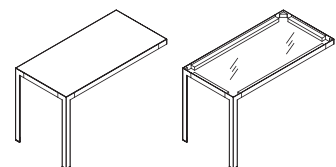

100x60x75h

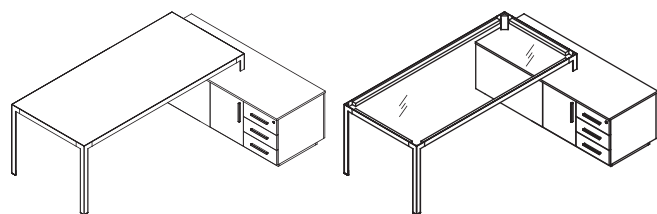

210/230x167x75h

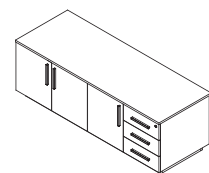

167x61x55h

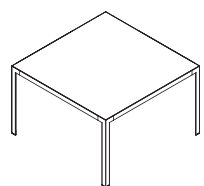

120x120x75h

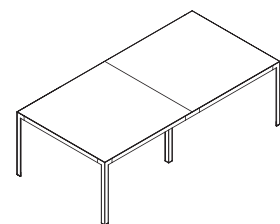

240x120x75h

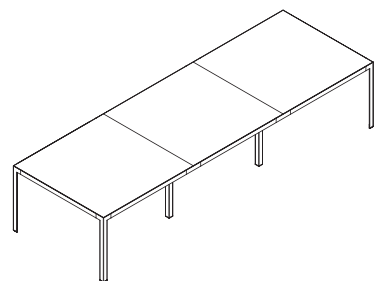

360x120x75h

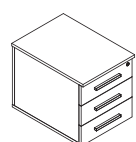

41x56x50h

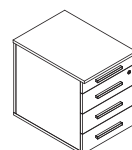

41x56x57h

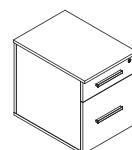

41x56x57h

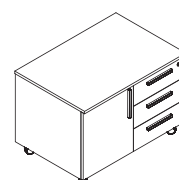

84x58x59h

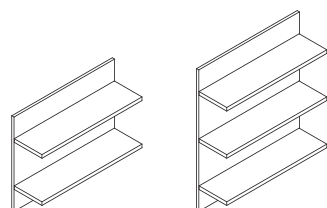

80/120x24x65h

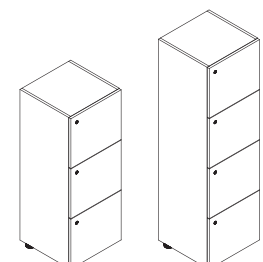

45 x 45 x 119/158h

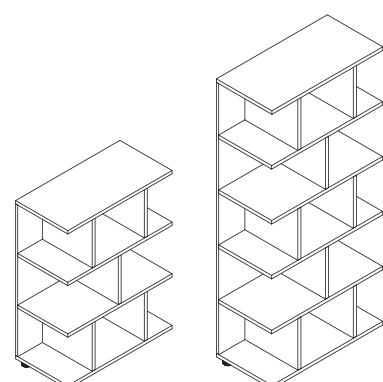

90x45x121/198h

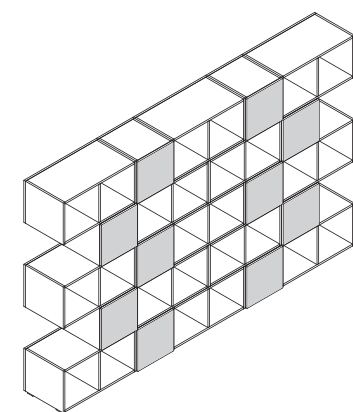

320x45x201h

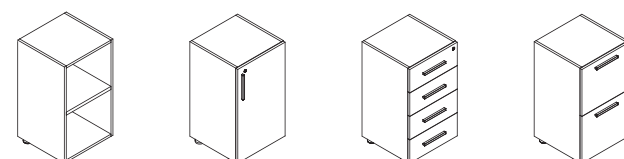

45x45x80h

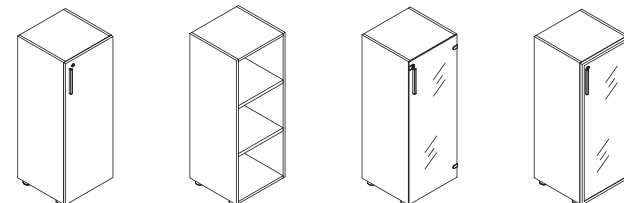

45x45x119h

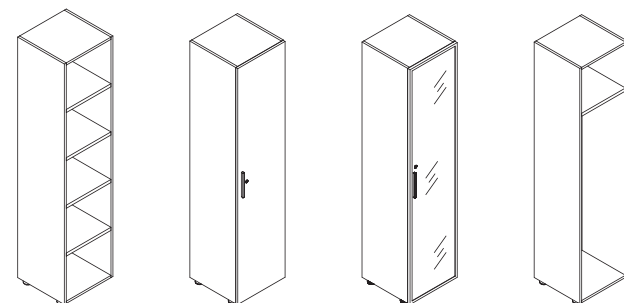

45x45x196h

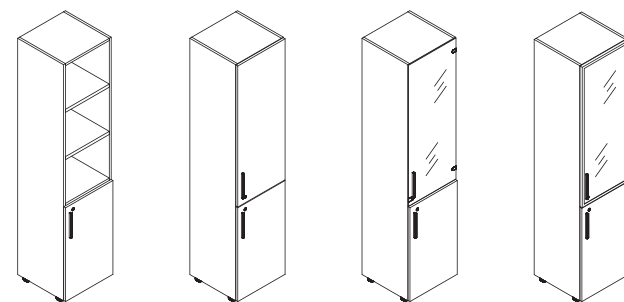

45x45x196h

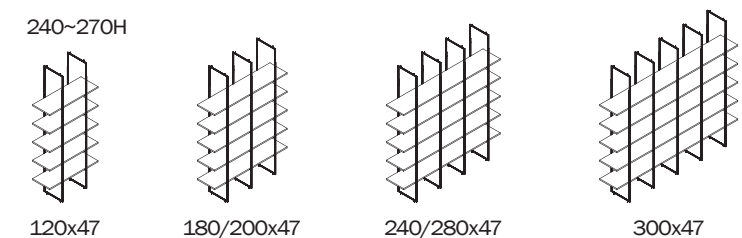

120x47

180/200x47

240/280x47

300x47

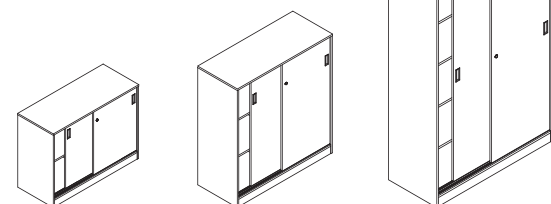

120x50x90/130/200h

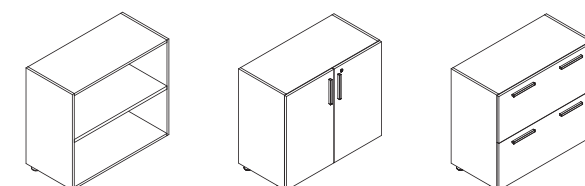

90x45x80h

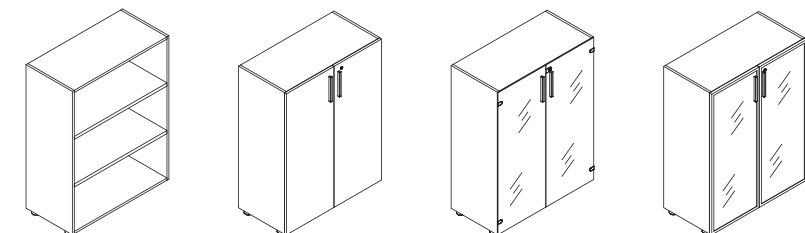

90x45x119h

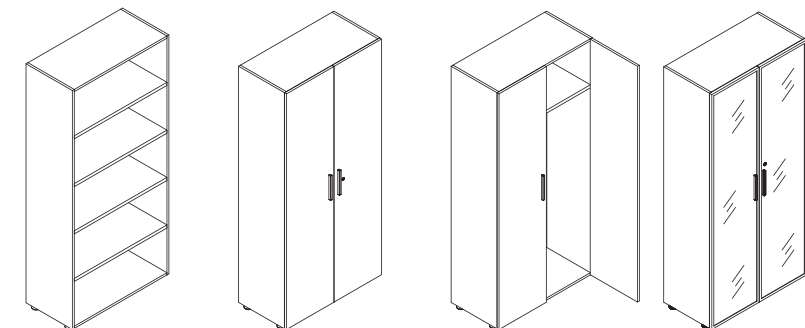

90x45x196h

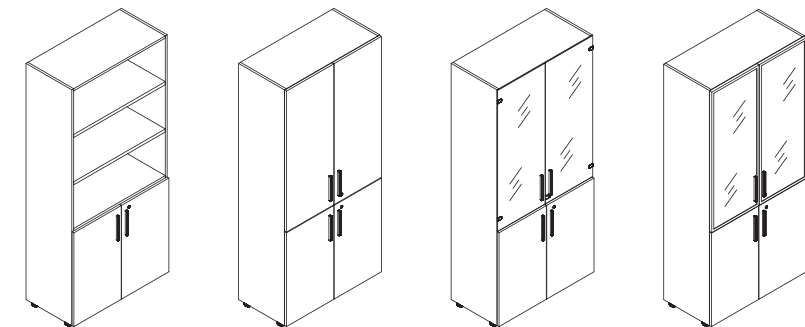

90x45x196h

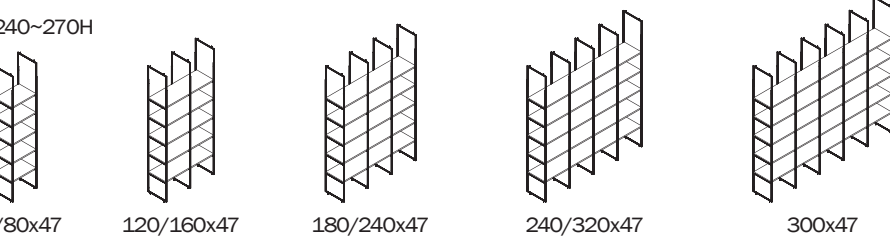

60/80x47

120/160x47

180/240x47

240/320x47

300x47

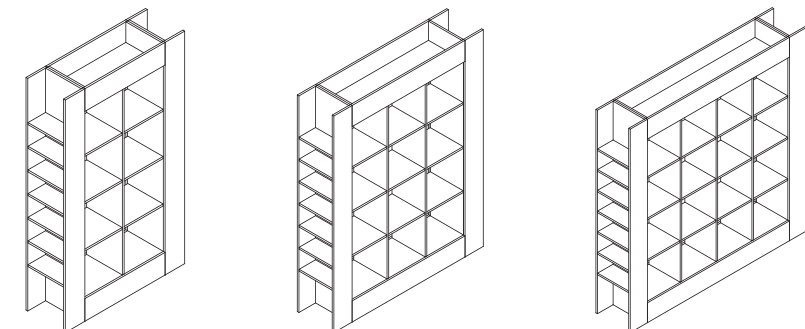

122x40x206h

164x40x206h

206x40x206h



COMPIR S.r.l.
C.da Mannanici S.N.
95048 Scordia (CT)
ITALY

T. +39 095 7937011
T. +39 095 7935015

M. commerciale@compir.it
W. www.flycom.it

Creativity: BIEFFERENDER VR
Printed by: EUROTIPPO VR
SETTEMBRE 2023

COMPIR si riserva la facoltà di modificare, in qualunque momento e senza preavviso, le caratteristiche tecniche degli elementi illustrati nel presente catalogo. Declina ogni responsabilità per eventuali inesattezze contenute nello stesso.

COMPIR reserves the right to modify, at any time and without notice, the technical characteristics of the elements illustrated in this catalogue. The company declines all responsibility for any inaccuracies that there may be in the catalogue.

